

TW-139107 Vacuum Cleaner Motor

OUTPUT POWER: 600 ~1200 W (APPROX)

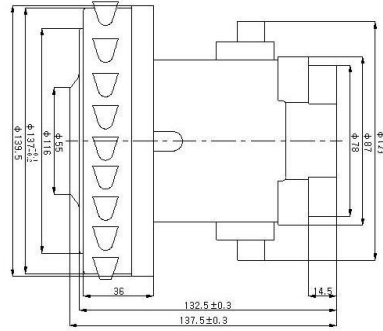

Specification	Model	TW-139	TW-139	Tolerance Value
	Voltage(V)	220 230 240 100 110 120	220 230 240 100 110 120	/
	Frequency(Hz)	50/60	50/60	/
	Input (W)	1000	1200	±10%
	Max Vacuum Degree(KPa)	19	20	-5%
	Max Air Quantity(m3/min)	3	3.1	-8%
	Temp.Rise(K)	<85	<85	/
	Noisy(dB)	96	98	/
	Sparkle Grade	<2 Level	<2 Level	/
	Insulation Grade	B	B	/
	Max Eff.(%)	35	35	-10%

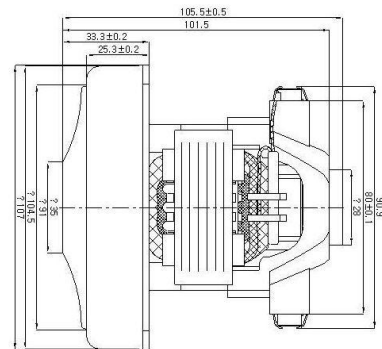

Specification	Model	TW-107	TW-107	Tolerance Value
	Voltage(V)	220 230 240 100 110 120	220 230 240 100 110 120	/
	Frequency(Hz)	50/60	50/60	/
	Input (W)	800	1000	±10%
	Max Vacuum Degree(KPa)	20	22	-5%
	Max Air Quantity(m3/min)	2.3	2.4	-8%
	Temp.Rise(K)	<85	<85	/
	Noisy(dB)	92	94	/
	Sparkle Grade	<2 Level	<2 Level	/
	Insulation Grade	B	B	/
	Max Eff.(%)	36	36	-10%